

MINI USB FEMALE SMT 5P

USB SERIES



Mechanical

- Mating : 35N max
- Withdrawal force: 7N min, initial
3N min after 5000 cycles
- Durability: 5000 cycles min.

Electrical

- Current-max [amps]: 1.0A
- Voltage-max [volts]: 30V
- Withstanding voltage: 100V AC
- Contact resistance [ohms]: 50 milliohms max
- Insulation resistance [ohms]: 100 megaohms min

Environmental

- Temperature range: -55°C to +85°C

Ordering Information

USB - S 05 B B

1 2 3 4

1. Connector Series
2. Number of pins per row (05=5P)
3. Color
 - B = Black
4. Type
 - B = B-type

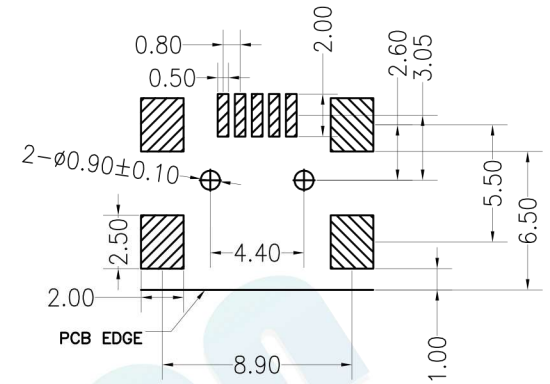
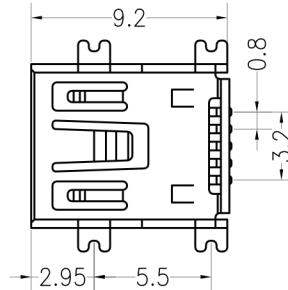
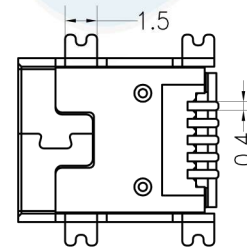
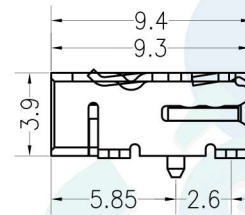
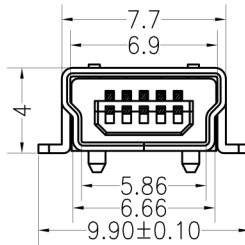
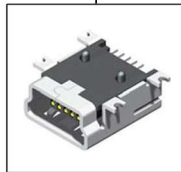

RECOMMENDED P.C.B. PATTERN LAYOUT

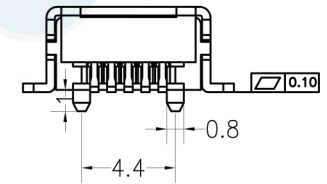

				OPERATION		DRAW	BEN	12.04.18	SCALE	FIT			
				X.X	±0.30				UNIT	mm			
				X.XX	±0.20	CHECK		SIZE	A4	PART NO.			USB-S05BB
				X.XXX	±0.10	APPROVE		SHEET	1/1	TITLE:			MINI USB-5P SMT
REV	DATE	MODIFICATION DESCRIPTION	CHANGE	DIM	TOL			PROJ.					