

PART NO. 6607xxHD051
DWG NO. C6607HD

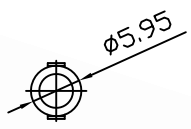

Part No.: 660702HD051

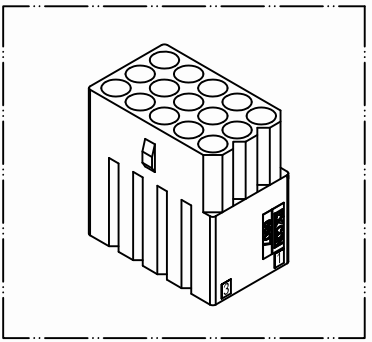
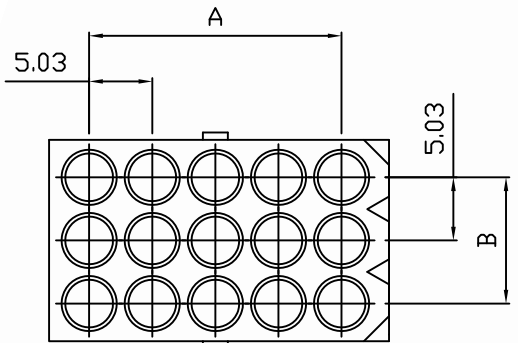
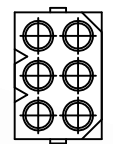

Part No.: 660706HD051

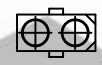

Part No.: 660702HD051

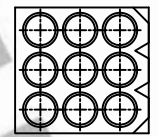

Part No.: 660703HD051

Part No.: 660709HD051

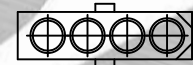

Part No.: 660704HD051

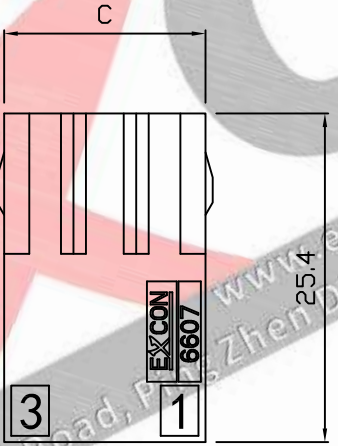
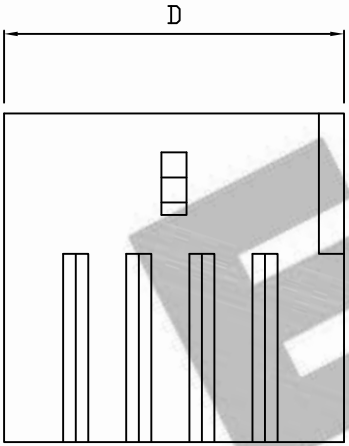
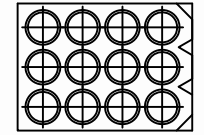

Part No.: 660712HD051

Part No.: 660705HD051

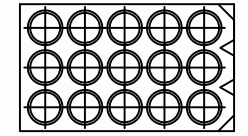
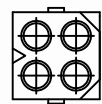
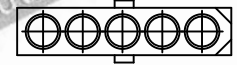

Part No.: 6607A4HD051

Part No.: 660715HD051

NOTE:

1. Wafer Material: Nylon 66 UL94 V2
2. Insulation resistance: 1000M ohm/min.
3. Withstand voltage: 1500V AC/minute.
4. Current retang: 5A AC/DC.
5. Voltage rating: 600V AC/DC
6. Color: Natural

Dimensional & Ordering Information:

Part No.	Circuits	Dim A	Dim B	Dim C	Dim D
660702HD051	2	5.03	---	6.35	11.38
660703HD051	3	10.06	---	6.35	16.41
660704HD051	4	15.09	---	6.35	21.44
6607A4HD051	4	5.03	5.03	11.38	11.38
660705HD051	5	20.12	---	6.35	26.47
660706HD051	6	5.03	10.06	16.41	11.38
660709HD051	9	10.06	10.06	16.41	16.41
660712HD051	12	15.09	10.06	16.41	21.44
660715HD051	15	20.12	10.06	16.41	26.47

REV.	REVISION	DIS	DATE	UNLESS OTHERWISE SPECIFIED TOLERANCES 3 PLACE ± 0.5 ± 0.10 2 PLACE ± 1.5 ± 0.25 1 PLACE ± 2.0 ± 0.50 ANGLE DIM	 EXCON TECHNOLOGY COMPANY
SCALE	REV.	PAGE	UNIT		
1/1	A	1/2	THIRD ANGLE PROJECTION	C6607HD	6607xxHD051

PART NO. 6607xxHM051
 DWG NO. C6607HM

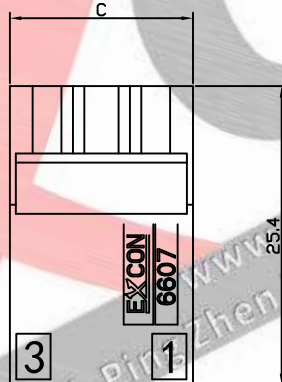
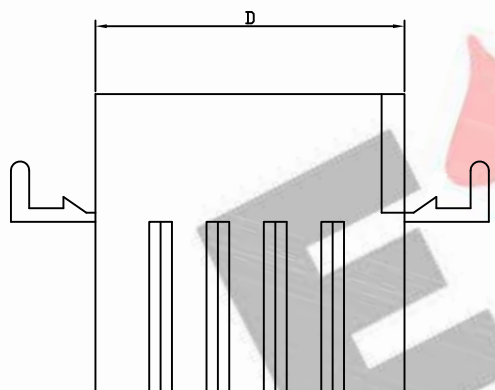
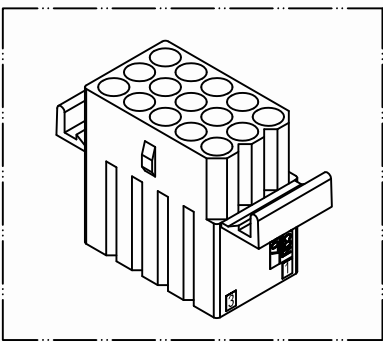
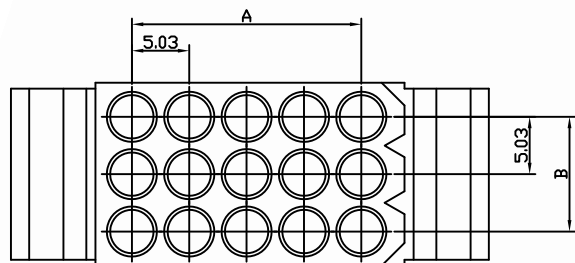

Part No.: 660702HM051

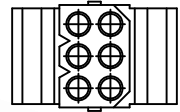

Part No.: 660706HM051



Part No.: 660703HM051

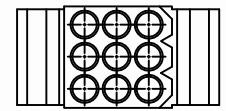

Part No.: 660709HM051



Part No.: 660704HM051

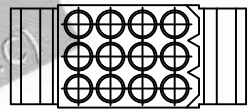

Part No.: 660712HM051



Part No.: 660705HM051

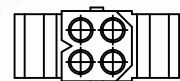

Part No.: 6607A4HM051

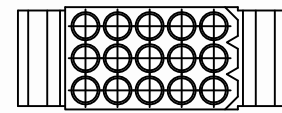

Part No.: 660715HM051

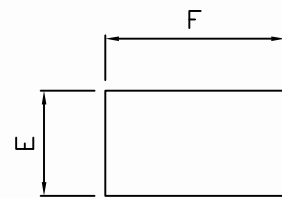

Dimensional & Ordering Information:

Part No.	Circuits	Dim A	Dim B	Dim C	Dim D	Dim E	Dim F
660702HD051	2	5.03	--	6.35	11.38	7.92	18.42
660703HD051	3	10.06	--	6.35	16.41	7.92	23.45
660704HD051	4	15.09	--	6.35	21.44	7.92	28.48
6607A4HD051	4	5.03	5.03	11.38	11.38	12.95	18.42
660705HD051	5	20.12	--	6.35	26.47	7.92	33.51
660706HD051	6	5.03	10.06	16.41	11.38	17.98	18.42
660709HD051	9	10.06	10.06	16.41	16.41	17.98	23.45
660712HD051	12	15.09	10.06	16.41	21.44	17.98	28.48
660715HD051	15	20.12	10.06	16.41	26.47	17.98	33.51

NOTE:

1. Wafer Material: Nylon 66 UL94 V2
2. Insulation resistance: 1000M ohm/min.
3. Withstand voltage: 1500V AC/minute.
4. Current retang: 5A AC/DC.
5. Voltage rating: 600V AC/DC
6. Color: Natural

LAYOUT

REV.	REVISIONI	DIS	DATE	UNLESS OTHERWISE SPECIFIED TOLERANCES 3 PLACE ±0.5 ±0.10 2 PLACE ±1.5 ±0.25 1 PLACE ±2.0 ±0.50 ANGLE DIM	 EXCON TECHNOLOGY COMPANY
SCALE	REV.	PAGE	UNIT		
1/1	A	1/2	THIRD ANGLE PROJECTION	C6607HM	6607xxHM051