

性能:
 额定电流: 0.5A
 额定电压: 50V
 耐电压: 500V
 接触电阻: 30mΩ
 绝缘电阻: 800MΩ
 工作温度: -20℃ ~ +85℃

塑件 (材质): LCP, UL94V-0
 插簧 (材质): 磷青铜, 镀锡/镀金

孔位	A	B	C
4	6.00	3.00	5.10
5	7.00	4.00	6.10
6	8.00	5.00	7.10
7	9.00	6.00	8.10
8	10.00	7.00	9.10
9	11.00	8.00	10.10
10	12.00	9.00	11.10
11	13.00	10.00	12.10
12	14.00	11.00	13.10
13	15.00	12.00	14.10
14	16.00	13.00	15.10
15	17.00	14.00	16.10
16	18.00	15.00	17.10
17	19.00	16.00	18.10
18	20.00	17.00	19.10
19	21.00	18.00	20.10
20	22.00	19.00	21.10
21	23.00	20.00	22.10
22	24.00	21.00	23.10
23	25.00	22.00	24.10
24	26.00	23.00	25.10
25	27.00	24.00	26.10
26	28.00	25.00	27.10
27	29.00	26.00	28.10
28	30.00	27.00	29.10
29	31.00	28.00	30.10
30	32.00	29.00	31.10
31	33.00	30.00	32.10
32	34.00	31.00	33.10
33	35.00	32.00	34.10
34	36.00	33.00	35.10
35	37.00	34.00	36.10

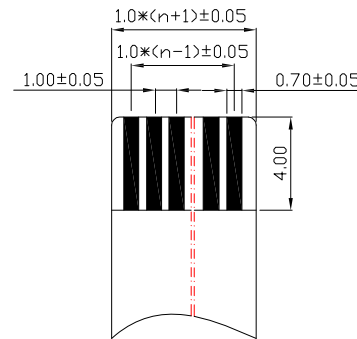
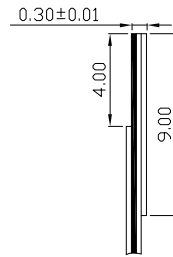
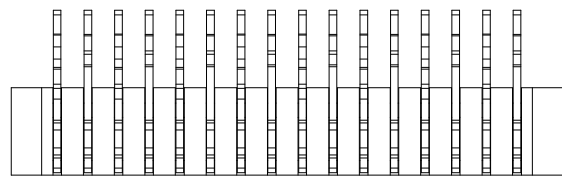
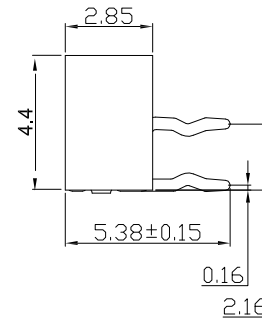
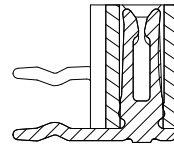
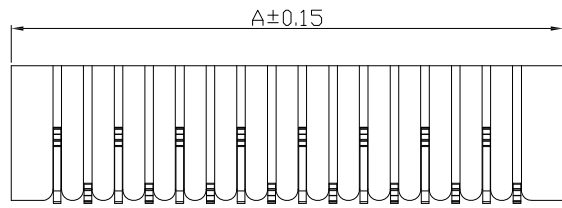

适用扁平电缆

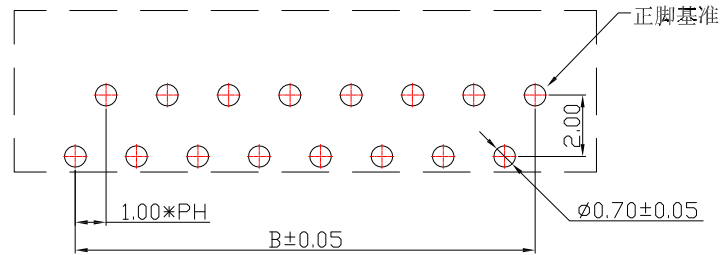

PCB LAYOUT

UNITS	mm
MAT'L	
FINISH	
Q'TY	PCS

PART NO.(INTENDED USE)	TITLE:
1. 0-B-nPW	1. 0双面接弯插
APPD:	DWG NO.:
	1. 0-B-nPW
CHKD:	SCALE
DR: HU 2016. 09. 28	1/1
	SHEET
	1/1
	REV.
	A

